



Digital Pressure Gauge

Battery Powered or IO-Link



measuring
•
monitoring
•
analysing

MAN-SC/-LC



Display rotatable in 90° steps

2 x 180°

With optional rubber protection sleeve

IO-Link



- 5-digit LCD display
- Capacitive touchpads
- Peak memory
- Analogue output, frequency output, switch output (MAN-LC)
- IO-Link function (MAN-LC)
- Up to 2 relays possible (MAN-LC)
- Selectable measuring units
- Tara function
- Stainless steel process connection
- Assembly of numerous diaphragm seals possible
- Rubber protection sleeve for tough operating conditions
- MAN-SC: power supply via 9V block battery
- Battery life: up to 2 ½ years
- MAN-LC: external power supply via 24 V_{DC}



KOBOLD companies worldwide:

AUSTRALIA, AUSTRIA, BELGIUM, BULGARIA, CANADA, CHINA, CZECHIA, FRANCE, GERMANY, GREAT BRITAIN, HUNGARY, INDIA, INDONESIA, ITALY, MALAYSIA, MEXICO, NETHERLANDS, PERU, POLAND, REPUBLIC OF KOREA, RUSSIA, SPAIN, SWITZERLAND, THAILAND, TUNISIA, TURKEY, USA, VIETNAM

KOBOLD Messring GmbH
Nordring 22-24
D-65719 Hofheim/Ts.
Head Office:
+49(0)6192 299-0
+49(0)6192 23398
info.de@kobold.com
www.kobold.com

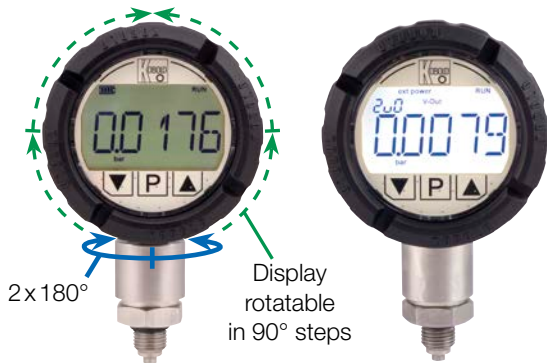

Description

The intelligent KOBOLD digital manometers are used for the display, monitoring and remote transmission of pressure-dependent operating sequences in machines and installations. The pressure to be measured is sensed by a ceramic, or metal sensor, and displayed by the electronics. With the MAN-LC version, two universally configurable signal outputs are available. Instead of outputs, the optionally available relay board may drive up to two potential-free relays. The values are shown on a five-digit LCD display. The electronics module can be rotated at 90° intervals. In the pressure switch design with integrated relay, the switching point and hysteresis can be set on the membrane keypad. A wide range of process connections are available as an option. The process connection can be axially rotated as desired, after loosening the counter nut.

Examples of Application

- Mechanical engineering and plant construction
- Pumps and compressors
- Environmental technology
- Hydraulics and pneumatics
- Service jobs
- Process industry
- Load Capacity Measuring (e. g. Tensile Load Measurement with Pull Tester)

Technical Details

General

Display: 5-digit alpha-numeric reflective LC-display, 14-segment » better readability under direct sunlight and low ambient light « (MAN-LC with white backlight and transfective display)
 Digit height 16 mm
 Shows Primary Value (pressure "P") and Secondary Value (Force "F") permanent or alternating (Change time: 5 s).
 Display Menu Level 3-digit, 7-segment, digit height 4.5 mm

Programming buttons: capacitive (touchpads)

Housing: Ø 80 mm, PA6 GK30, front display polycarbonate

Measuring ranges: -1...0...+1600 bar (special measuring ranges on request)

Accuracy class ¹⁾: 0.5 at reference conditions ²⁾ ±1 digit

¹⁾ Including non-linearity, hysteresis, zero-point- and end-value deviation (corresponds to measured error per IEC 61298-2).

²⁾ Reference conditions: temperature 21 °C, air pressure 860 ... 1060 mbar, humidity <90 % r. F. (non-condensing)

Temperature error at -20 ... +85 °C:

Temperature influence (overall): ±0,25 % of full scale/ 10 K

Temperature coefficient: Zero-point ≤ ±0.2% of full scale/10 K
 Range ≤ ±0.1 % of full scale/10 K

Long term stability: ≤ ±0.2 % of full scale/year at reference conditions

Adjustability of zero-point: ≤ ±100% of full scale (via Tara function)

Overload range: 3 x PN (to 40 bar)
 2 x PN (60 ... 160 bar)
 1.5 x PN (250 ... 1600 bar)

Power-up time: ca. 5 s

Response time: 0.5 ... 1 s (with display refresh time 1 s)

Conversion rate internal: 10 per second

Display and outputs refresh: 1 ... 10 s

Software functions

Function	MAN-SC	MAN-LC
Min/Max Peak memory	yes	yes
Sleep mode (Automatic power-off)	yes	no
Password protection	yes	yes
Reset to factory setting	yes	yes
Measuring units (customer selectable)	kPa, MPa, bar, mbar, psi, kN, N, torr, inWC, mmWC, inHg, USR (user-defined measuring unit)	
Force measurement	yes	yes
Tara function	yes	yes
Control input (for MIN-/MAX-memory reset)	no	yes

Calculation of Force Value F: The measured Force Value is calculated from the measured pressure value and a programmable reference area:
 Force [N] = 10 x AREA x Pressure Measured Value
 with AREA = Reference Area in [mm²] and Pressure Measured Value in [bar]

Rubber protection sleeve (optional): thermoplastic Elastomer, serves as protection against impact



Supply voltage

MAN-LC external supply 18 – 32V_{DC} via M12x1 connector
current consumption max. 200 mA (without outputs)

MAN-SC battery 6LR61 (nominal voltage 9V)

Battery status display: yes, via 4 segments

Sleep mode: programmable (for maximising battery lifespan)

Sleep mode	Description	Power consumption*	Note
-	-	~55 µA	Normal measuring mode
0	LC-Display is switched off.	~45 µA	Marginal energy saving via display switch-off. Measurement keeps running.
1	LC-Display is switched off and the measurement stopped.	~20 µA	Fast operational readiness after wake-up (1 to 2 s).
2	Unit in deep sleep mode. No measurement	~13 µA	Unit starts fresh after wake-up. Operational readiness after ca. 5 s. Suitable for storage with installed battery.

* Average current consumption with a 9 V battery

Battery lifespan

Battery type 6LR61 (9V)	Lifespan (typical at 20°C)
Alkaline 600 mAh	up to 9000 h (~ 1 year)*
Lithium 1300 mAh	up to 22500 h (~2.5 years)*

* Self battery-discharging not considered. The battery capacity reduces with low ambient temperatures.

Wetted parts

Sensor: ceramic (Al₂O₃) (meas. range ≤ 700 bar)
st. st. (1.4571) (meas. range >700 bar)

Gasket/Temperature of medium

Gasket	Measuring range	Temperature of medium
none, stainless steel welded	> 700 bar	-30 ... +85 °C
NBR (standard)	≤ 700 bar	-30 ... +85 °C
FKM, FFKM (optional)	≤ 700 bar	-30 ... +85 °C
EPDM (optional)	≤ 700 bar	-30 ... +85 °C (+135 °C with cooling fin)

Process connections

Norm	Thread size
EN837	G ¼ B (standard)
	G ½ B
ANSI/ASME B1.20.1	¼" NPT
	½" NPT
For other process connections see table Order Details	

Ambient temp.: -10 ... +60 °C
Storage temp.: -30 ... +80 °C
Allowed relative humidity: <90 %, non-condensing

Protection class (acc. IEC 60529): IP65
Electrical connection: M12x1 round connector (5 or 8-pin)

Electrical outputs (MAN-LC)

Frequency output (OUT1/OUT2): Push-pull, max. 1000 Hz, free scalable, linear to Pressure/Force
Accuracy ≤ ±1,5% of output frequency

Alarm output (OUT1/OUT2): NPN, PNP, Push-Pull configurable max. 30V_{DC}, max. 200 mA short-circuit proof

Analogue output (OUT2): active, 3-wire, free scalable
0(4) - 20 mA max. load 500 Ω
or
0(2) - 10V_{DC}, (R_{Load} ≥ 50 kΩ, load error ≤ 1 %)

Control input (OUT1): MIN/MAX RESET
OUT1, High active
0 < U_{Low} < 10V_{DC}
15V_{DC} < U_{High} < Vs

IO-Link (OUT1): Manufacturer ID: 1105 (decimal), 0x0451 (hex)
Name of manufacturer: Kobold Messring GmbH
IO-Link specification: V1.1
Bit rate: COM2
Minimal cycle time: 10 ms
SIO-Mode: yes (OUT1 in configuration IO-Link)
Block parameterisation: yes
Operational readiness: 10 s
Max. cable length: 20 m

Configuration of outputs MAN-LC...

Output 1 (OUT 1, PIN 4)	Output 2 (OUT 2, PIN 2)
	Analogue output 4-20 mA
	Analogue output 0-20 mA
	Analogue output 2-10 V
	Analogue output 0-10 V
Alarm output NPN/PP	Alarm output NPN/PP
Frequency output PP	Frequency output PP
Communication mode KofiCom	
Communication mode IO-Link	
Control input	
SPDT contact (optional with ZUB-MANS-KON2)	SPDT contact (optional with ZUB-MANS-KON2)

Shock resistance
DIN EN 60068-2-27:2010: 20 g (11 ms)

Vibration resistance
DIN EN 60068-2-6:2008: 5 g (10 ... 2000 Hz)

Weight (connection G ¼): MAN-SC: ca. 360 g
MAN-LC: ca. 310 g
(Weights of other process connections deviate)







Order Details (Example: MAN-SC10 G2A3000)



Model	Output	Mechanical connection	Measuring range ¹⁾	Electrical connection	Sensor gasket	Special version
MAN-SC (digital manometer with ceramic sensor, 9 V battery)	10 = without	Meas. range -1...+1600 bar: G4 = G 1/2 male	AC = -0,6...0 bar AD = -1...0 bar A0 = -1...+0,6 bar A1 = -1...+1,5 bar A2 = -1...+3 bar A3 = -1...+5 bar A4 = -1...+9 bar A5 = -1...+15 bar	0 = without		
MAN-LC (digital manometer with backlight, 18-32 V _{DC} supply)	30 = with 2 configurable outputs (OUT1, OUT2)	Meas. range -1...+1000 bar: G2 = G 1/4 male N2 = 1/4" NPT male N4 = 1/2" NPT male Meas. range -1...+700 bar: K2 = Connection bottom G 1/4 male, with cooling fins K4 = Connection bottom G 1/2 male, with cooling fins C2 = Connection bottom 1/4" NPT, with cooling fins C4 = Connection bottom 1/2" NPT, with cooling fins M1 = Connection bottom M16x1.5 male M2 = Connection bottom M20x1.5 male M6 = Connection M6 female with O-ring groove U7 = Connection bottom 7/16-20 UNF DIN 3866 D2 = Connection bottom G 1/4 male DIN 3852-E + FPM gasket YY = on request DM ²⁾ = Assembly with diaphragm seal	B1 = 0...+0,6 bar B2 = 0...+1 bar B3 = 0...+1,6 bar B4 = 0...+2,5 bar B5 = 0...+4 bar B6 = 0...+6 bar B7 = 0...+10 bar B8 = 0...+16 bar B9 = 0...+25 bar B0 = 0...+40 bar C1 = 0...+60 bar C2 = 0...+100 bar C3 = 0...+160 bar C9 ³⁾ = 0...+200 bar C4 = 0...+250 bar C5 = 0...+400 bar C6 = 0...+600 bar C0 ³⁾ = 0...700 bar D7 = 0...1000 bar D8 = 0...1600 bar EC = -20...0 inHg ED = -30...0 inHg E0 ⁴⁾ = -30...+15 inHg/psi E1 ⁴⁾ = -30...+30 inHg/psi E2 ⁴⁾ = -30...+60 inHg/psi E3 ⁴⁾ = -30...+100 inHg/psi E4 ⁴⁾ = -30...+150 inHg/psi F1 = 0...+10 psi F2 = 0...+15 psi F3 = 0...+30 psi F4 = 0...+50 psi F5 = 0...+60 psi F6 = 0...+100 psi F7 = 0...+150 psi F8 = 0...+200 psi F9 = 0...+300 psi F0 = 0...+500 psi G1 = 0...+1000 psi G2 = 0...+1450 psi G3 = 0...+2000 psi G4 = 0...+2300 psi G5 = 0...+3000 psi G6 = 0...+3600 psi G7 = 0...+5000 psi G8 = 0...+5800 psi G9 = 0...+7500 psi G0 = 0...+10000 psi H1 = 0...+15000 psi H2 = 0...+20000 psi	S= M12x1 connector	0 = NBR (standard, from 700 bar fully welded without gasket) 1 = FKM 2 = EPDM 3 = FFKM 4 = PTFE	0 = without L ⁵⁾ = 9 V lithium battery A ⁶⁾ = absolute pressure 0...1,0 to 0...10 bar S = oil and fat free for oxygen Y = special (please specify in writing)



¹⁾ Custom selectable measuring units: kPa, MPa, bar, mbar, psi, kN, N, torr, inWC, mmWC, inHg, USR
²⁾ Diaphragm seal model and application data to be specified in clear text. Application Index on the last two pages of this data sheet to be filled out, or discuss with your local KOBOLD technical sales office. For a summary of diaphragm seal models and possible ranges, see page 11 and following. For dimensional details consult our DRM data sheet at www.kobold.com.
 In case of ordering a remote diaphragm seal with capillary and for mounting with wall mounting bracket MZB-709... acc. to DIN 16286, an additional ordering of the adaptor model MZB-708/... acc. to DIN 16281 for factory sided integration in diaphragm seal assembly is mandatory.
³⁾ Measuring range for hydraulic applications
⁴⁾ Display in psi
⁵⁾ instead of 9 V alkaline – shipping without air freight (MAN-SC only)
⁶⁾ for measuring ranges B2 to B7 / F2 to F7

Accessories for standard versions

Order code	Description	Image
ZUB-MANS-KON1	Pluggable retrofit kit with 2x potential-free SPDT contact, comprising of a relay board and 2 x socket head cap screws M2x16 (only for MAN-LC...) Switching capacity per contact: 30V _{AC/DC} , max. 1 A	
ZUB-MANS-KON2	Pluggable retrofit kit with 2x potential-free SPDT contact, comprising of a relay board and 2 x socket head cap screws M2x16 and 8-pin M12 connector (only for MAN-LC...) Switching capacity per contact: 30V _{AC/DC} , max. 1 A	
ZUB-MANS-KAP01	Rubber protection sleeve MAN-SC/-LC, black	
ZUB-MANS-KAP02	Rubber protection sleeve MAN-SC/-LC, orange	

Accessories for M12x1 round connector

Round connector, M12x1 socket, straight								
Technical Details	Image							
	Order code	ZUB-KAB-12D500	ZUB-KAB-12K502	ZUB-KAB-12K505	ZUB-KAB-12K510	ZUB-KAB-12K802	ZUB-KAB-12K805	ZUB-KAB-12K810
Way of connection	Screws	2 m PUR cable moulded	5 m PUR cable moulded	10 m PUR cable moulded	2 m PUR cable moulded	5 m PUR cable moulded	10 m PUR cable moulded	
Male insert	PBT / PA66	PUR			PUR			
Ring nut	PA66	Zinc die casting / Brass, nickel-plated			Zinc die casting / Brass, nickel-plated			
Cable outlet/ cable diameter	4 - 6 mm	6 mm			6 mm			
Cross section of wire	max. 0.75 mm ²	0.34 mm ²			0.25 mm ²			
Number of contacts	5	5			8			
Protection	IP 67	IP 67			IP 67			
Rated voltage	60 V	60 V			60 V			
Rated current	4 A	2 A			2 A			
Ambient temperature	-40 ... +85 °C	-25 ... +80 °C		-25 ... +85 °C	-25 ... +80 °C		-25 ... +85 °C	

Round connector, M12x1 socket, straight		Round connector, M12x1 socket, angled						
Technical Details	Image							
	Order code	ZUB-KAB-12D800	ZUB-KAB-12W502	ZUB-KAB-12W505	ZUB-KAB-12W510	ZUB-KAB-12W802	ZUB-KAB-12W805	ZUB-KAB-12W810
Way of connection	Screws	2 m PUR cable moulded	5 m PUR cable moulded	10 m PUR cable moulded	2 m PUR cable moulded	5 m PUR cable moulded	10 m PUR cable moulded	
Male insert	PA	PUR			PUR			
Ring nut	CuZn (brass)	Zinc die casting / Brass, nickel-plated			Zinc die casting / Brass, nickel-plated			
Cable outlet/ cable diameter	6 - 8 mm	6 mm			6 mm			
Cross section of wire	max. 0.5 mm ²	0.34 mm ²			0.25 mm ²			
Number of contacts	8	5			8			
Protection	IP 67	IP 67			IP 67			
Rated voltage	30 V	60 V			60 V			
Rated current	2 A	2 A			2 A			
Ambient temperature	-25 ... +85 °C	-25 ... +85 °C	-25 ... +80 °C		-25 ... +85 °C	-25 ... +80 °C		

Electrical connection MAN-LC
Plug version, 5-pin

Plug version (Basic)	MAN-LC30 (standard version, delivery scope)
PIN 1	Supply +Vs
PIN 2	Output 2
PIN 3	Supply GND
PIN 4	Output 1 IO-Link
PIN 5	-

Possible options for customer modification, 5-pin, with optional retrofit kit ZUB-MANS-KON1*

5-pin	Modification	PIN 1	PIN 2	PIN 3	PIN 4	PIN 5	Order code**
Option 5.1 (recommended)	2 N/O contacts, 1 common Relay COM	Supply +Vs	Relay 2 N/O contact	Supply GND	Relay 1 N/O contact	Relay 1+2 Relay COM	ABG-MANLC51
Option 5.2	2 N/C contacts, 1 common Relay COM	Supply +Vs	Relay 2 N/C contact	Supply GND	Relay 1 N/C contact	Relay 1+2 Relay COM	ABG-MANLC52
Option 5.3	1 N/C contact, 1 N/O contact, 1 Relay COM	Supply +Vs	Relay 2 N/C contact	Supply GND	Relay 1 N/O contact	Relay 1+2 Relay COM	ABG-MANLC53
Option 5.4	1 Output IO-Link, 1 N/O contact, 1 Relay COM	Supply +Vs	Relay 2 N/O contact	Supply GND	Output 1 IO-Link	Relay 2 Relay COM	ABG-MANLC54
Option 5.5	1 Output IO-Link, 1 N/C contact, 1 Relay COM	Supply +Vs	Relay 2 N/C contact	Supply GND	Output 1 IO-Link	Relay 1 Relay COM	ABG-MANLC55
Option 5.6	1 Output 4...20 mA, 1 N/O contact, 1 Relay COM	Supply +Vs	Output 2 (4...20 mA)	Supply GND	Relay 1 N/O contact	Relay 1 Relay COM	ABG-MANLC56
Option 5.7	1 Output 4...20 mA, 1 N/C contact, 1 Relay COM	Supply +Vs	Output 2 (4...20 mA)	Supply GND	Relay 1 N/C contact	Relay 1 Relay COM	ABG-MANLC57

* Modification instructions included in instruction manual

** Factory configuration, possible while ordering a new unit

Possible options for customer modification, 8-pin, with optional retrofit kit ZUB-MANS-KON2*

8-pin	Modification	PIN 1	PIN 2	PIN 3	PIN 4	PIN 5	PIN 6	PIN 7	PIN 8	Order code**
Option 8.1 (recommended)	1 Output 4...20 mA, 1 N/C contact, 1 N/O contact, 1 Relay COM	Supply +Vs	Output 2 (4...20 mA)	Supply GND	Relay 1 Relay 1 COM	Relay 1 N/O contact	Relay 1 N/C contact	-	-	ABG-MANLC81
Option 8.2	2 N/C contacts, 2 N/O contacts, 2 Relay COM*	Supply +Vs	Relay 2 Relay 2 COM	Supply GND	Relay 1 Relay 1 COM	Relay 1 N/O contact	Relay 1 N/C contact	Relay 2 N/O contact	Relay 2 N/C contact	ABG-MANLC82
Option 8.3	1 Output IO-Link, 1 N/C contact, 1 N/O contact, 1 Relay COM*	Supply +Vs	Relay 2 Relay 2 COM	Supply GND	Output 1 IO-Link	-	-	Relay 2 N/O contact	Relay 2 N/C contact	ABG-MANLC83

* Modification instructions included in instruction manual

** Factory configuration, possible while ordering a new unit



Display Layout

MAN-SC

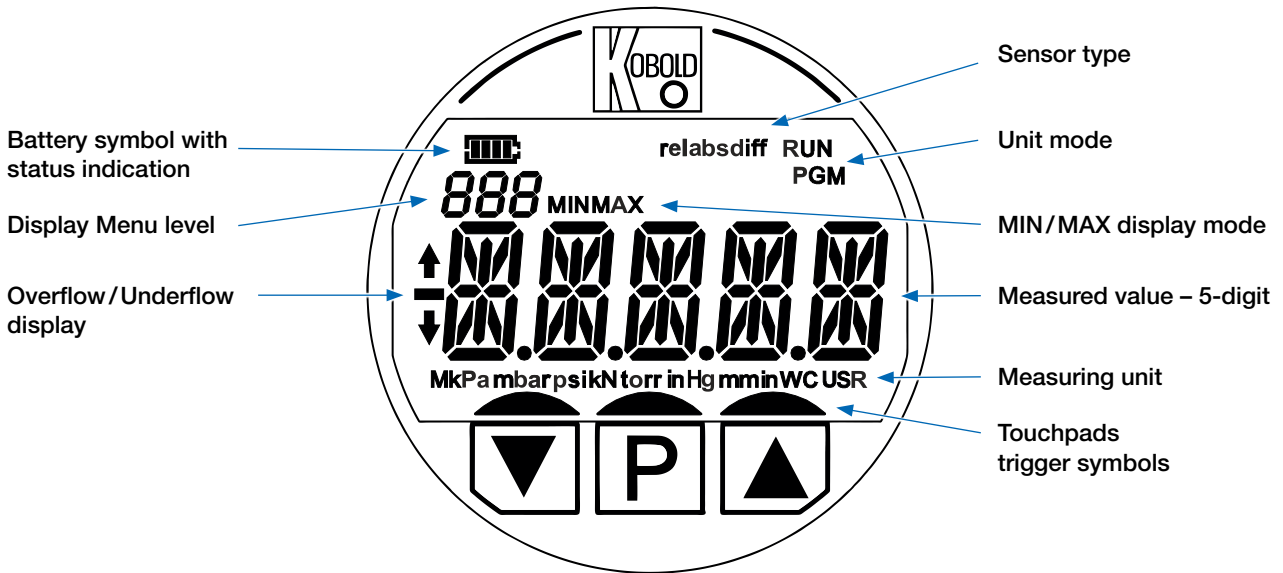

MAN-LC

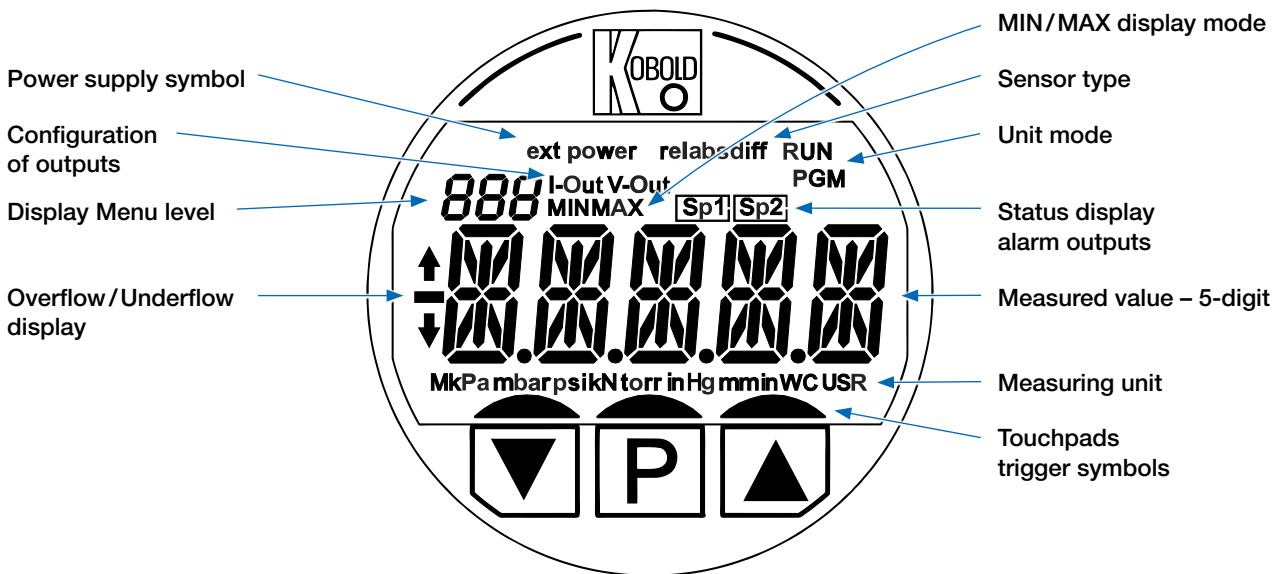

Dimensions [mm]

MAN-SC

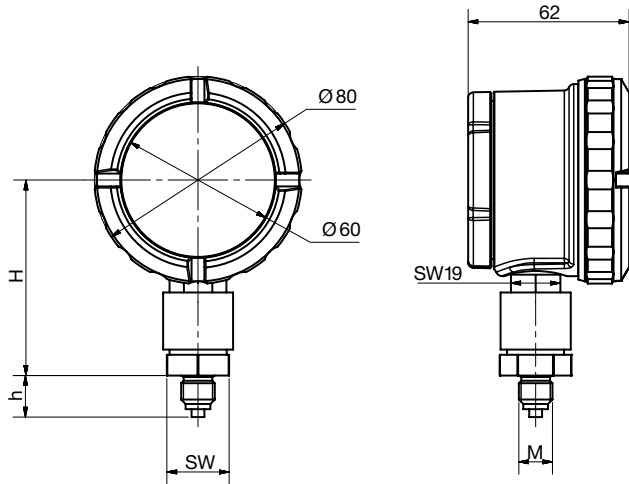

Rubber protection sleeve ZUB-MANS-KAP01 (optional)

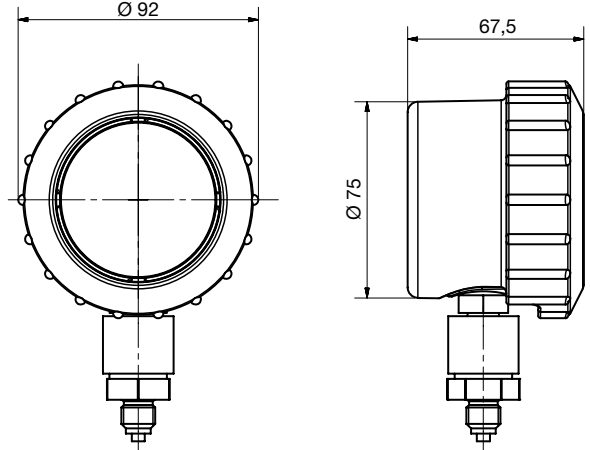

MAN-LC

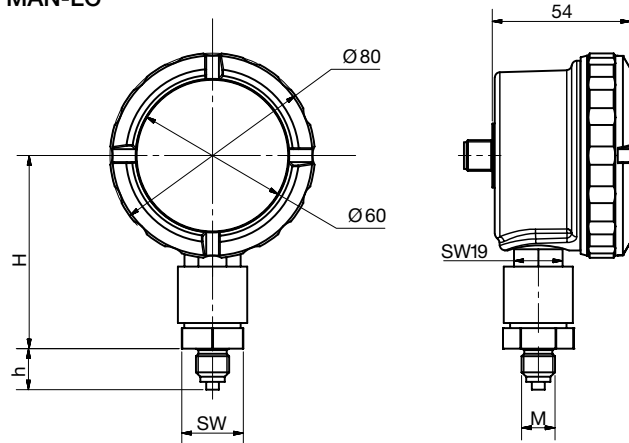

Mechanical connection	Code	M	SW [mm]	H+2 mm [mm]*	h [mm]
G 1/4 male	G2	G 1/4 male	24	75	16.5
G 1/2 male	G4	G 1/2 male	24	75	25.5
1/4" NPT male	N2	1/4" NPT	24	75	14.5
1/2" NPT male	N4	1/2" NPT	24	75	19
G 1/4 male *** 1000 + 1600 bar / 15+20 k PSI	G2	G 1/4 male	27	83	16.5
G 1/2 male *** 1000 + 1600 bar / 15+20 k PSI	G4	G 1/2 male	27	83	25.5
1/4" NPT male *** 1000 + 1600 bar / 15+20 k PSI	N2	1/4" NPT	27	83	14.5
1/2" NPT male *** 1000 + 1600 bar / 15+20 k PSI	N4	1/2" NPT	27	84	19
Connection bottom G 1/4 male with cooling fins ***	K2	G 1/4 male	24	94.5	16.5
Connection bottom G 1/2 male with cooling fins ***	K4	G 1/2 male	24	94.5	25.5
Connection bottom 1/4" NPT with cooling fins ***	C2	1/4" NPT	24	94.5	14.5
Connection bottom 1/2" NPT with cooling fins ***	C4	1/2" NPT	24	94.5	19
Connection bottom M20x1.5 male	M2	M20x1.5	24	78	23.5
Connection bottom M16x1.5 male	M1	M16x1.5	24	78	23.5
Connection M6 female with O-ring groove	M6	M6 female	24	75	-
7/16 UNF DIN 3866 stainless steel	U7	7/16 UNF	24	75	15
G 1/4 male DIN 3852-E stainless steel + FPM gasket	D2	G 1/4 male	24	75	12

* The counter nut at the sensor can be loosened by the customer and the electronic housing rotated max. 360°. This changes the height H by approx. +1.75 mm (corresponds to thread slope). This rotation enables any orientation of the unit after final mounting is done.

Example of MAN-SC/-LC direct assembled with diaphragm seal
(for dimensional details, see DRM data sheet)

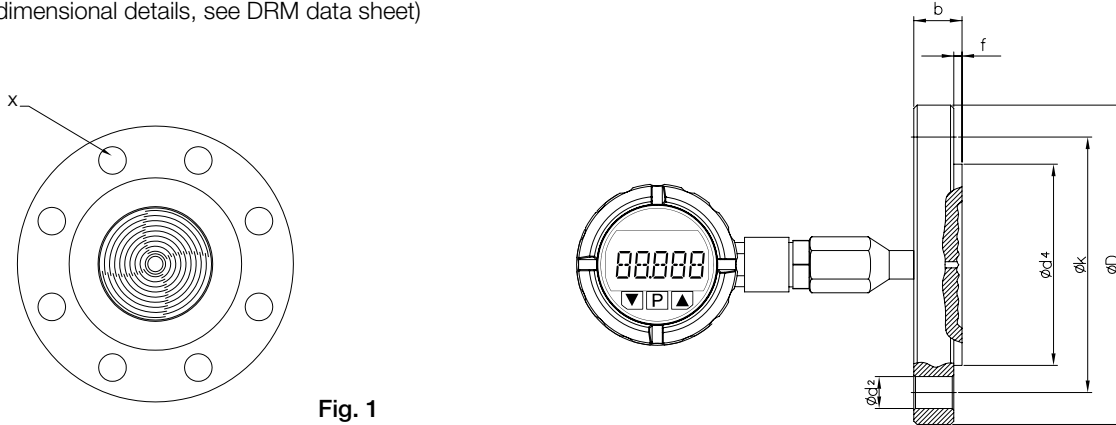

Fig. 1

Example of MAN-SC/-LC remote assembled with diaphragm seal and capillary
(for dimensional details, see DRM data sheet)

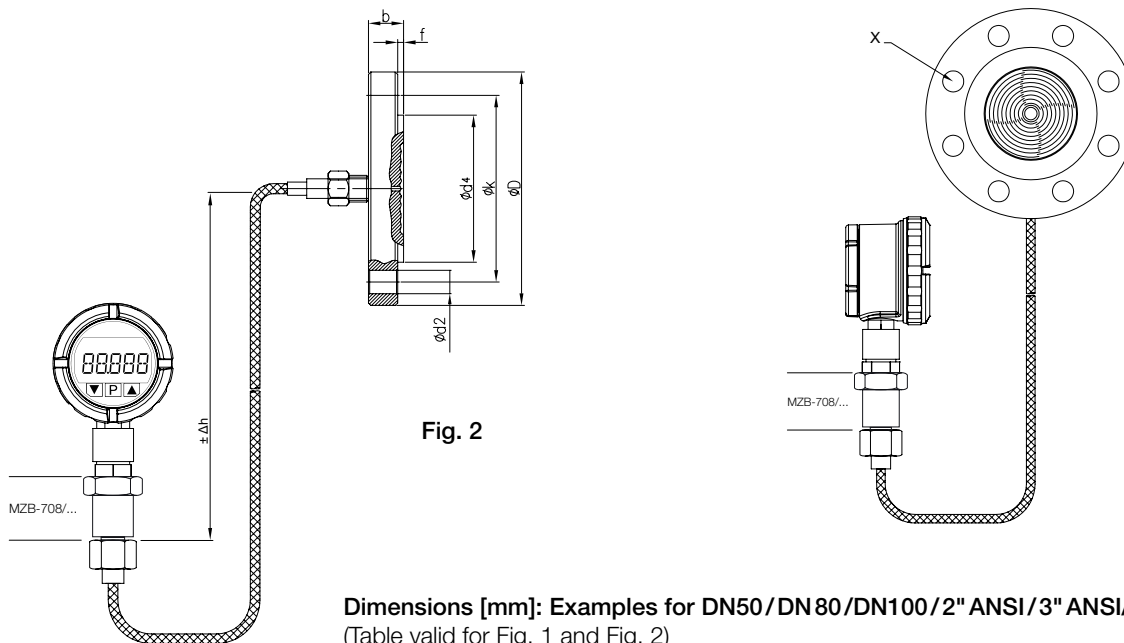

Fig. 2

Dimensions [mm]: Examples for DN50/DN 80/DN100/ 2" ANSI/3" ANSI/4" ANSI
(Table valid for Fig. 1 and Fig. 2)

Flange type	D	k	d ²	b	f	d ⁴	X
DN50 PN16	165	125	18	18	2	102	4
DN50 PN40	165	125	18	20	2		4
2" ANSI Cl. 150	152.4	120.6	19	19.1	2	92	4
2" ANSI Cl. 300	165.1	127	19	22.3	2		8
DN80 PN16	200	160	18	20	2	138	8
DN80 PN40	200	160	18	24	2		8
3" ANSI Cl. 150	190.5	152.4	19	23.9	1.6	127	4
3" ANSI Cl. 300	209.5	168.3	22	28.4	1.6		8
DN100 PN16	220	180	18	20	2	149	8
DN100 PN40	235	190	22	24	2		8
4" ANSI Cl. 150	228.6	190.5	19	24	1.6	157.2	8
4" ANSI Cl. 300	254	200	22	32	1.6		8

Example of MAN-SC/LC remote assembled with extended diaphragm seal and capillary
 (for dimensional details, see DRM data sheet)

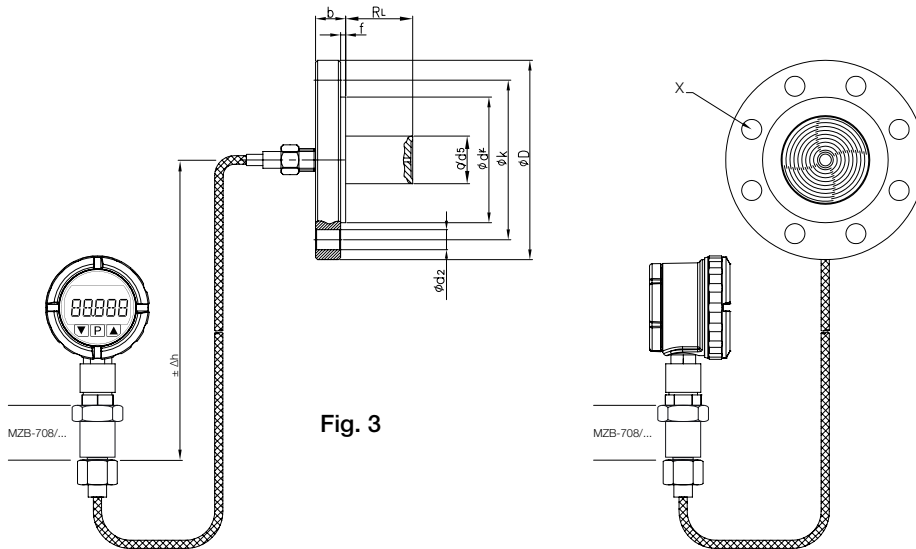

Fig. 3

Dimensions [mm]: Examples for DN50/DN80/DN100/2" ANSI/3" ANSI/4" ANSI

Flange type	D	k	d ²	b	f	d ⁴	X	d ⁵	R _L
DN50 PN16	165	125	18	18	2	102	4	48	50 mm (2")/ 100 mm (4")/ 150 mm (6")/ 200 mm (8")/ (customer specified)
DN50 PN40	165	125	18	20	2		4	48	
2" ANSI Cl. 150	152.4	120.6	19	19.1	2	92	4	48	
2" ANSI Cl. 300	165.1	127	19	22.3	2		8	48	
DN80 PN16	200	160	18	20	2	138	8	76	
DN80 PN40	200	160	18	24	2		8	76	
3" ANSI Cl. 150	190.5	152.4	19	23.9	1.6	127	4	76	
3" ANSI Cl. 300	209.5	168.3	22	28.4	1.6		8	76	
DN100 PN16	220	180	18	20	2	149	8	89	
DN100 PN40	235	190	22	24	2	149	8	89	
4" ANSI Cl. 150	228.6	190.5	19	24	1.6	157.2	8	89	
4" ANSI Cl. 300	254	200	22	32	1.6	157.2	8	89	

Diaphragm seal models (direct or remote assembly)

(Standard device without additional options (e.g. coatings, special materials etc.).

For dimensions/technical data, see DRM data sheet. Accuracy: Class 0.5 + influence of seal).



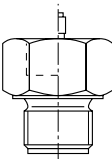
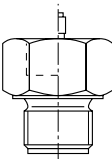
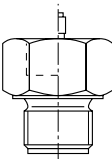
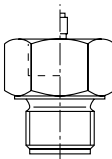

Over and under ranges of the min./max. span might be possible, but must be verified by Kobold for each application.

The indicated min./max. spans do not consider any coating of diaphragm seals. For additional information contact Kobold.



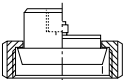
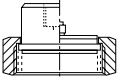
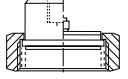
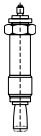
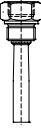

Model DRM	Size code	Size	Note	Ø Diaphragm	Max. medium temperature	Min. span [bar]	Max. span [bar]																																																									
DRM-189 	F23	Ø 18	for homogenising machines, direct	Ø 18	+120 °C	0...4	1000																																																									
	<table border="1"> <tr> <td rowspan="12"> DRM-600  </td> <td>R15</td> <td>G ½</td> <td rowspan="12">fixed male thread, direct</td> <td>Ø 18</td> <td rowspan="12">+100 °C</td> <td>0...4*</td> <td>1000</td> </tr> <tr> <td>R20</td> <td>G ¾</td> <td>Ø 23.8</td> <td>0...1.6*</td> <td>1000</td> </tr> <tr> <td>R25</td> <td>G 1</td> <td>Ø 29.5</td> <td>0...1</td> <td>600</td> </tr> <tr> <td>R32</td> <td>G 1 ¼</td> <td>Ø 38</td> <td>0...0.6</td> <td>600</td> </tr> <tr> <td>R40</td> <td>G 1 ½</td> <td>Ø 40</td> <td>0...0.6</td> <td>600</td> </tr> <tr> <td>N15</td> <td>½" NPT</td> <td>Ø 18</td> <td>0...4*</td> <td>1000</td> </tr> <tr> <td>N20</td> <td>¾" NPT</td> <td>Ø 18</td> <td>0...4*</td> <td>1000</td> </tr> <tr> <td>N25</td> <td>1" NPT</td> <td>Ø 23.8</td> <td>0...1.6</td> <td>600</td> </tr> <tr> <td>N32</td> <td>1 ¼" NPT</td> <td>Ø 34.5</td> <td>0...1</td> <td>600</td> </tr> <tr> <td>M20</td> <td>M20 x 1,5</td> <td>Ø 18</td> <td>0...4</td> <td>600</td> </tr> <tr> <td>M48</td> <td>M 48 x 3</td> <td>Ø 40</td> <td>0...0.6</td> <td>600</td> </tr> </table>							DRM-600 	R15	G ½	fixed male thread, direct	Ø 18	+100 °C	0...4*	1000	R20	G ¾	Ø 23.8	0...1.6*	1000	R25	G 1	Ø 29.5	0...1	600	R32	G 1 ¼	Ø 38	0...0.6	600	R40	G 1 ½	Ø 40	0...0.6	600	N15	½" NPT	Ø 18	0...4*	1000	N20	¾" NPT	Ø 18	0...4*	1000	N25	1" NPT	Ø 23.8	0...1.6	600	N32	1 ¼" NPT	Ø 34.5	0...1	600	M20	M20 x 1,5	Ø 18	0...4	600	M48	M 48 x 3	Ø 40	0...0.6
DRM-600 	R15	G ½	fixed male thread, direct	Ø 18	+100 °C	0...4*	1000																																																									
	R20	G ¾		Ø 23.8		0...1.6*	1000																																																									
	R25	G 1		Ø 29.5		0...1	600																																																									
	R32	G 1 ¼		Ø 38		0...0.6	600																																																									
	R40	G 1 ½		Ø 40		0...0.6	600																																																									
	N15	½" NPT		Ø 18		0...4*	1000																																																									
	N20	¾" NPT		Ø 18		0...4*	1000																																																									
	N25	1" NPT		Ø 23.8		0...1.6	600																																																									
	N32	1 ¼" NPT		Ø 34.5		0...1	600																																																									
	M20	M20 x 1,5		Ø 18		0...4	600																																																									
	M48	M 48 x 3		Ø 40		0...0.6	600																																																									
	DRM-601 	R15		G ½		fixed male thread with capillary	Ø 18	+200 °C	0...4*	1000																																																						
R20		G ¾	Ø 23.8	0...1.6*	1000																																																											
R25		G 1	Ø 29.5	0...1	600																																																											
R32		G 1 ¼	Ø 38	0...0.6	600																																																											
R40		G 1 ½	Ø 40	0...0.6	600																																																											
N15		½" NPT	Ø 18	0...4*	1000																																																											
N20		¾" NPT	Ø 18	0...4*	1000																																																											
N25		1" NPT	Ø 23.8	0...1.6	600																																																											
N32		1 ¼" NPT	Ø 34.5	0...1	600																																																											
M20		M20 x 1,5	Ø 18	0...4	600																																																											
M48		M 48 x 3	Ø 40	0...0.6	600																																																											

* On request only after technical clarification

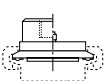
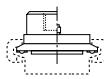

Diaphragm seal models (direct or remote assembly) (continued)

Model DRM	Size code	Size	Note	Ø Diaphragm	Max. medium temperature	Min. span [bar]	Max. span [bar]
DRM-603 DIN 11851 	R20	DN 20	dairy connection, capillary	Ø 18	+200 °C	0...4	40
	R25	DN 25		Ø 23.8		0...1.6	40
	R32	DN 32		Ø 29.5		0...1	40
	R40	DN 40		Ø 38		0...0.6	40
	R50	DN 50		Ø 45.5		0...0.4	25
	R65	DN 65		Ø 64		0...0.25	25
	R80	DN 80		Ø 64		0...0.25	25
R1H	DN 100	Ø 64	0...0.25	25			
DRM-604 IDF 	R25	1"	IDF socket with union nut, direct	Ø 29.5	+100 °C	0...1.6	40
	R40	1 ½"		Ø 42		0...1	40
	R50	2"		Ø 56		0...0.6	40
DRM-605 IDF 	R25	1"	IDF socket with union nut, capillary	Ø 29.5	+200 °C	0...1	40
	R40	1 ½"		Ø 42		0...0.6	40
	R50	2"		Ø 56		0...0.4	40
DRM-606 	R20	G¾	capsule seal with rotatable male, capillary	short capsule	+350 °C	0...6	600
	R28	M28 x 1.5				0...6	600
DRM-607 	R15	G½	capsule seal with fixed male, direct	long capsule	+100 °C	0...1	600
	R20	G¾				0...1	600
DRM-607/1 	R15	G¾	Capsule seal with fixed male, direct	long capsule	+100 °C	0...1	600
	R20	G1				0...1	600
DRM-608/1 	R20	G¾	capsule seal with union nut, capillary	long capsule	+350 °C	0...1	600
	R25	G1	capsule seal with union nut, capillary	long capsule		0...1	600
DRM-610 SMS 	R40	1 ½"	SMS socket with union nut, direct	Ø 34.5	+100 °C	0...1	40
	R50	2"		Ø 45.5		0...0.4	40





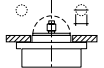

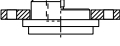
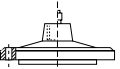
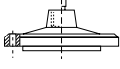
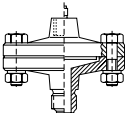
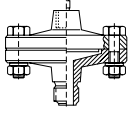
Diaphragm seal models (direct or remote assembly) (continued)

Model DRM	Size code	Size	Note	Ø Diaphragm	Max. medium temperature	Min. span [bar]	Max. span [bar]
DRM-611 SMS 	R40	1 ½"	SMS socket with union nut, capillary	Ø 34.5	+200 °C	0...1	40
	R50	2"		Ø 45.5		0...0.4	40
DRM-612 Clamp 	R25	1"	Tri-Clamp®, direct	Ø 18	+100 °C	0...4	16
	F40	1 ½"		Ø 35.5		0...1	16
	F50	2"		Ø 45.5		0...0.4	16
	R65	2 ½"		Ø 52		0...0.4	16
	R80	3"		Ø 64		0...0.25	10
DRM-613 Clamp 	R25	1"	Tri-Clamp®, capillary	Ø 18	+200 °C	0...4	16
	F40	1 ½"		Ø 35.5		0...1	16
	F50	2"		Ø 45.5		0...0.4	16
	R65	2 ½"		Ø 52		0...0.4	16
	R80	3"		Ø 64		0...0.25	10
DRM-614 APV-RJT 	R20	1"	union-nut, direct	Ø 29.5	+100 °C	0...1.6	100
	R40	1 ½"		Ø 42.5		0...0.6	100
	R50	2"		Ø 56		0...0.4	100
DRM-615 APV-RJT 	R20	1"	union-nut, capillary	Ø 29.5	+200 °C	0...1.6	100
	R40	1 ½"		Ø 42.5		0...0.6	100
	R50	2"		Ø 56		0...0.4	100
DRM-616 	R45	M45 x 2	union-nut, direct	Ø 23.8	+100 °C	0...1.6	1600
DRM-617 	R45	M45 x 2	union-nut, capillary	Ø 23.8	+120 °C	0...1.6	1600



Diaphragm seal models (direct or remote assembly) (continued)

Model DRM	Size code	Size	Note	Ø Diaphragm	Max. medium temperature	Min. span [bar]	Max. span [bar]
 DRM-620	R20	G $\frac{3}{4}$	union-nut, capillary	Ø 23.8	+350 °C	0...1.6	600
	DRM-620/1	R20	G $\frac{3}{4}$	union-nut, capillary	Ø 23.8	+350 °C	0...1.6
 DRM-621	F38	Ø 38 mm	flange, direct	Ø 38	+250 °C	0...0.4	40
 DRM-622	F48	Ø 48 mm	flange, direct	Ø 48	+100 °C	0...0.4	40
	F48 1	Ø 48 mm		Ø 48		0...0.4	40
	F48 2	Ø 48 mm		Ø 48		0...0.4	40
 DRM-622/1	F48	Ø 48 mm	flange, capillary	Ø 48	+200 °C	0...0.4	40
	F48 1	Ø 48 mm		Ø 48		0...0.4	40
	F48 2	Ø 48 mm		Ø 48		0...0.4	40
 DRM-624	F1H	Ø 100 mm	flange, direct	Ø 63.5	+100 °C	0...0.25	40
	F1H T	Ø 100 mm	flange, direct			0...0.25	40
 DRM-624/1	F1H	Ø 100 mm	flange, capillary		+250 °C	0...0.25	40
 DRM-625	R15	G $\frac{1}{2}$	fix male, direct	Ø 63.5	+100 °C	0...0.25	40
	N15	$\frac{1}{2}$ " NPT				0...0.25	40
	I15	G $\frac{1}{2}$ female				0...0.25	40
 DRM-625/1	R15	G $\frac{1}{2}$	fix male, capillary	Ø 63.5	+250 °C	0...0.25	40
	N15	$\frac{1}{2}$ " NPT				0...0.25	40
	I15	G $\frac{1}{2}$ female				0...0.25	40

Diaphragm seal models (direct or remote assembly) (continued)

Model DRM	Size code	Size	Note	Ø Diaphragm	Max. medium temperature	Min. span [bar]	Max. span [bar]
DRM-626 PN25 	R08 A025	G ¼ male	fix male, direct	Ø 56	+80 °C	0...0.4	25
	R08 I025	G ¼ female	fix female, direct	Ø 56		0...0.4	25
	R15 A025	G ½ male	fix male, direct	Ø 56		0...0.4	25
	R15 I025	G ½ female	fix female, direct	Ø 56		0...0.4	25
	N15 A025	½" NPT male	fix male, direct	Ø 56		0...0.4	25
DRM-626 PN100 	R08 A100	G ¼ male	fix male, direct	Ø 56	+80 °C	0...0.4	100
	R08 I100	G ¼ female	fix female, direct	Ø 56		0...0.4	100
	R15 A100	G ½ male	fix male, direct	Ø 56		0...0.4	100
	R15 I100	G ½ female	fix female, direct	Ø 56		0...0.4	100
	N15 A100	½" NPT male	fix male, direct	Ø 56		0...0.4	100
DRM-626 PN250 	R08 A250	G ¼ male	fix male, direct	Ø 56	+80 °C	0...0.4	250
	R08 I250	G ¼ female	fix female, direct	Ø 56		0...0.4	250
	R15 A250	G ½ male	fix male, direct	Ø 56		0...0.4	250
	R15 I250	G ½ female	fix female, direct	Ø 56		0...0.4	250
	N15 A250	½" NPT male	fix male, direct	Ø 56		0...0.4	250
DRM-627 PN25 	R08 A025	G ¼ male	fix male, capillary	Ø 56	+250 °C	0...0.4	25
	R08 I025	G ¼ female	fix female, capillary	Ø 56		0...0.4	25
	R15 A025	G ½ male	fix male, capillary	Ø 56		0...0.4	25
	R15 I025	G ½ female	fix female, capillary	Ø 56		0...0.4	25
	N15 A025	½" NPT male	fix male, capillary	Ø 56		0...0.4	25
DRM-627 PN100 	R08 A100	G ¼ male	fix male, capillary	Ø 56	+250 °C	0...0.4	100
	R08 I100	G ¼ female	fix female, capillary	Ø 56		0...0.4	100
	R15 A100	G ½ male	fix male, capillary	Ø 56		0...0.4	100
	R15 I100	G ½ female	fix female, capillary	Ø 56		0...0.4	100
	N15 A100	½" NPT male	fix male, capillary	Ø 56		0...0.4	100
DRM-627 PN250 	R08 A250	G ¼ male	fix male, capillary	Ø 56	+250 °C	0...0.4	250
	R08 I250	G ¼ female	fix female, capillary	Ø 56		0...0.4	250
	R15 A250	G ½ male	fix male, capillary	Ø 56		0...0.4	250
	R15 I250	G ½ female	fix female, capillary	Ø 56		0...0.4	250
	N15 A250	½" NPT male	fix male, capillary	Ø 56		0...0.4	250
DRM-628 PN06 	F25P06	DN25	flange to EN1092-1, direct	Ø 24	+80 °C	0...1.6	6
	F32P06	DN32		Ø 30		0...1.6	6
	F40P06	DN40		Ø 38		0...0.6	6
	F50P06	DN50		Ø 48		0...0.4	6
	F65P06	DN65		Ø 64		0...0.25	6
	F80P06	DN80		Ø 64		0...0.25	6
	N1HP06	DN100		Ø 64		0...0.25	6
DRM-628 PN16 	F25P16	DN25	flange to EN1092-1, direct	Ø 24	+80 °C	0...1.6	16
	F32P16	DN32		Ø 30		0...1.6	16
	F40P16	DN40		Ø 38		0...0.6	16
	F50P16	DN50		Ø 48		0...0.4	16
	F65P16	DN65		Ø 64		0...0.25	16
	F80P16	DN80		Ø 64		0...0.25	16
	N1HP16	DN100		Ø 64		0...0.25	16
DRM-628 PN40 	F25P40	DN25	flange to EN1092-1, direct	Ø 24	+80 °C	0...1.6	40
	F32P40	DN32		Ø 30		0...1.6	40
	F40P40	DN40		Ø 38		0...0.6	40
	F50P40	DN50		Ø 48		0...0.4	40
	F65P40	DN65		Ø 64		0...0.25	40
	F80P40	DN80		Ø 64		0...0.25	40
	N1HP40	DN100		Ø 64		0...0.25	40

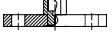
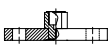
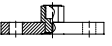
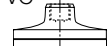
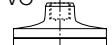
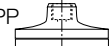
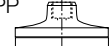
Diaphragm seal models (direct or remote assembly) (continued)

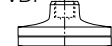
Model DRM	Size code	Size	Note	Ø Diaphragm	Max. medium temperature	Min. span [bar]	Max. span [bar]
DRM-629 PN06 	F25P06	DN25	flange to EN1092-1, capillary	Ø 24	+250 °C	0... 1.6	6
	F32P06	DN32		Ø 30		0... 1.6	6
	F40P06	DN40		Ø 38		0... 0.6	6
	F50P06	DN50		Ø 48		0... 0.4	6
	F65P06	DN65		Ø 64		0... 0.25	6
	F80P06	DN80		Ø 64		0... 0.25	6
	F1HP06	DN100		Ø 64		0... 0.25	6
DRM-629 PN16 	F25P16	DN25	flange to EN1092-1, capillary	Ø 24	+250 °C	0... 1.6	16
	F32P16	DN32		Ø 30		0... 1.6	16
	F40P16	DN40		Ø 38		0... 0.6	16
	F50P16	DN50		Ø 48		0... 0.4	16
	F65P16	DN65		Ø 64		0... 0.25	16
	F80P16	DN80		Ø 64		0... 0.25	16
	F1HP16	DN100		Ø 64		0... 0.25	16
DRM-629 PN40 	F25P40	DN25	flange to EN1092-1, capillary	Ø 24	+250 °C	0... 1.6	40
	F32P40	DN32		Ø 30		0... 1.6	40
	F40P40	DN40		Ø 38		0... 0.6	40
	F50P40	DN50		Ø 48		0... 0.4	40
	F65P40	DN65		Ø 64		0... 0.25	40
	F80P40	DN80		Ø 64		0... 0.25	40
	F1HP40	DN100		Ø 64		0... 0.25	40
DRM 630 PVC 	R08	G ¼ female	fix female, direct	Ø 64	+40 °C	0... 0.25	10
	R15	G ½ female		Ø 64		0... 0.25	10
	N15	½" NPT female		Ø 64		0... 0.25	10
DRM-630/1 PVC 	R08	G ¼ female	fix female, capillary	Ø 64	+40 °C	0... 0.25	10
	R15	G ½ female		Ø 64		0... 0.25	10
	N15	½" NPT female		Ø 64		0... 0.25	10
DRM-631 PP 	R08	G ¼ female	fix female, direct	Ø 64	+40 °C	0... 0.25	10
	R15	G ½ female		Ø 64		0... 0.25	10
	N15	½" NPT female		Ø 64		0... 0.25	10
DRM-631/1 PP 	R08	G ¼ female	fix female, capillary	Ø 64	+40 °C	0... 0.25	10
	R15	G ½ female		Ø 64		0... 0.25	10
	N15	½" NPT female		Ø 64		0... 0.25	10
DRM-632 PVDF 	R08	G ¼ female	fix female, direct	Ø 64	+50 °C	0... 0.25	16
	R15	G ½ female		Ø 64		0... 0.25	16
	N15	½" NPT female		Ø 64		0... 0.25	16
DRM-632/1 PVDF 	R08	G ¼ female	fix female, capillary	Ø 64	+50 °C	0... 0.25	16
	R15	G ½ female		Ø 64		0... 0.25	16
	N15	½" NPT female		Ø 64		0... 0.25	16



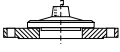
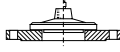
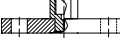
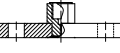
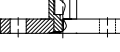
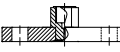
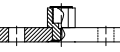

Diaphragm seal Models (direct or remote assembly) (continued)

Model DRM	Size code	Size	Note	Ø Diaphragm	Max. medium temperature	Min. span [bar]	Max. span [bar]
 DRM-633	F50	DN50	flange to DIN2527 Form C, direct	Ø 64	+100 °C	0...0.25	40
	F1H	DN 100		Ø 64		0...0.25	40
 DRM-633/1	F50	DN50	flange to DIN2527 Form C, capillary	Ø 64	+250 °C	0...0.25	40
	F1H	DN 100		Ø 64		0...0.25	40
 DRM-634 150 lbs	A25P150	1"	flange to ASME B16.5, direct	Ø 30	+80 °C	0... 1.6	10
	A32P150	1¼"		Ø 38		0...0.6	10
	A40P150	1 ½"		Ø 38		0...0.6	10
	A50P150	2"		Ø 48		0...0.4	10
	A65P150	2 ½"		Ø 48		0...0.4	10
	A80P150	3"		Ø 64		0...0.25	10
	A90P150	3 ½"		Ø 64		0...0.25	10
	A1HP150	4"		Ø 64		0...0.25	10
 DRM-634 300 lbs	A25P300	1"	flange to ASME B16.5, direct	Ø 30	+80 °C	0... 1.6	20
	A32P300	1¼"		Ø 38		0...0.6	20
	A40P300	1 ½"		Ø 38		0...0.6	20
	A50P300	2"		Ø 48		0...0.4	20
	A65P300	2 ½"		Ø 48		0...0.4	20
	A80P300	3"		Ø 64		0...0.25	20
	A90P300	3 ½"		Ø 64		0...0.25	20
	A1HP300	4"		Ø 64		0...0.25	20
 DRM-634 600 lbs	A25P600	1"	flange to ASME B16.5, direct	Ø 30	+80 °C	0... 1.6	40
	A32P600	1¼"		Ø 38		0...0.6	40
	A40P600	1 ½"		Ø 38		0...0.6	40
	A50P600	2"		Ø 48		0...0.4	40
	A65P600	2 ½"		Ø 48		0...0.4	40
	A80P600	3"		Ø 64		0...0.25	40
	A90P600	3 ½"		Ø 64		0...0.25	40
	A1HP600	4"		Ø 64		0...0.25	40
 DRM-634 1500 lbs	A25P1K5	1"	flange to ASME B16.5, direct	Ø 30	+80 °C	0... 1.6	100
	A32P1K5	1¼"		Ø 38		0...0.6	100
	A40P1K5	1 ½"		Ø 38		0...0.6	100
	A50P1K5	2"		Ø 48		0...0.4	100
	A65P1K5	2 ½"		Ø 48		0...0.4	100
	A80P1K5	3"		Ø 64		0...0.25	100
	A90P1K5	3 ½"		Ø 64		0...0.25	100
	A1HP1K5	4"		Ø 64		0...0.25	100
 DRM-635 150 lbs	A25P150	1"	flange to ASME B16.5, capillary	Ø 30	+250 °C	0... 1.6	10
	A32P150	1¼"		Ø 38		0...0.6	10
	A40P150	1 ½"		Ø 38		0...0.6	10
	A50P150	2"		Ø 48		0...0.4	10
	A65P150	2 ½"		Ø 48		0...0.4	10
	A80P150	3"		Ø 64		0...0.25	10
	A90P150	3 ½"		Ø 64		0...0.25	10
	A1HP150	4"		Ø 64		0...0.25	10

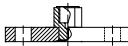

Diaphragm seal models (direct or remote assembly) (continued)

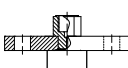
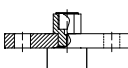
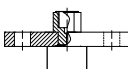
Model DRM	Size code	Size	Note	Ø Diaphragm	Max. medium temperature	Min. span [bar]	Max. span [bar]
DRM-635 300 lbs 	A25P300	1"	flange to ASME B16.5, capillary	Ø 30	+250 °C	0...1.6	20
	A32P300	1 ¼"		Ø 38		0...0.6	20
	A40P300	1 ½"		Ø 38		0...0.6	20
	A50P300	2"		Ø 48		0...0.4	20
	A65P300	2 ½"		Ø 48		0...0.4	20
	A80P300	3"		Ø 64		0...0.25	20
	A90P300	3 ½"		Ø 64		0...0.25	20
	A1HP300	4"		Ø 64		0...0.25	20
DRM-635 600 lbs 	A25P600	1"	flange to ASME B16.5, capillary	Ø 30	+250 °C	0...1.6	40
	A32P600	1 ¼"		Ø 38		0...0.6	40
	A40P600	1 ½"		Ø 38		0...0.6	40
	A50P600	2"		Ø 48		0...0.4	40
	A65P600	2 ½"		Ø 48		0...0.4	40
	A80P600	3"		Ø 64		0...0.25	40
	A90P600	3 ½"		Ø 64		0...0.25	40
	A1HP600	4"		Ø 64		0...0.25	40
DRM-635 1500 lbs 	A25P1K5	1"	flange to ASME B16.5, capillary	Ø 30	+250 °C	0...1.6	100
	A32P1K5	1 ¼"		Ø 38		0...0.6	100
	A40P1K5	1 ½"		Ø 38		0...0.6	100
	A50P1K5	2"		Ø 48		0...0.4	100
	A65P1K5	2 ½"		Ø 48		0...0.4	100
	A80P1K5	3"		Ø 64		0...0.25	100
	A90P1K5	3 ½"		Ø 64		0...0.25	100
	A1HP1K5	4"		Ø 64		0...0.25	100
DRM-637 PN06 	F25P06	DN25	flange to EN1092-1, direct	Ø 24	+80 °C	0...1.6	6
	F32P06	DN32		Ø 30		0...1.6	6
	F40P06	DN40		Ø 38		0...1	6
	F50P06	DN50		Ø 48		0...0.6	6
	F65P06	DN65		Ø 64		0...0.25	6
	F80P06	DN80		Ø 64		0...0.25	6
	N1HP06	DN100		Ø 64		0...0.25	6
DRM-637 PN16 	F25P16	DN25	flange to EN1092-1, direct	Ø 24	+80 °C	0...1.6	16
	F32P16	DN32		Ø 30		0...1.6	16
	F40P16	DN40		Ø 38		0...1	16
	F50P16	DN50		Ø 48		0...0.6	16
	F65P16	DN65		Ø 64		0...0.25	16
	F80P16	DN80		Ø 64		0...0.25	16
	N1HP16	DN100		Ø 64		0...0.25	16
DRM-637 PN40 	F25P40	DN25	flange to EN1092-1, direct	Ø 24	+80 °C	0...1.6	40
	F32P40	DN32		Ø 30		0...1.6	40
	F40P40	DN40		Ø 38		0...1	40
	F50P40	DN50		Ø 48		0...0.6	40
	F65P40	DN65		Ø 64		0...0.25	40
	F80P40	DN80		Ø 64		0...0.25	40
	N1HP40	DN100		Ø 64		0...0.25	40

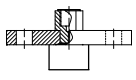
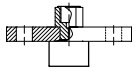
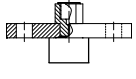
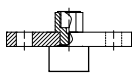
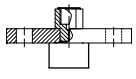
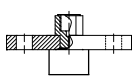

Diaphragm seal models (direct or remote assembly) (continued)

Model DRM	Code	Size	Note	Ø Diaphragm	Max. medium temperature	Min. span [bar]	Max. span [bar]
DRM-638 PN06 	F25P06	DN25	flange to EN1092-1, capillary	Ø 24	+250 °C	0...1.6	6
	F32P06	DN32		Ø 30		0...1.6	6
	F40P06	DN40		Ø 38		0...1	6
	F50P06	DN50		Ø 48		0...0.6	6
	F65P06	DN65		Ø 64		0...0.25	6
	F80P06	DN80		Ø 64		0...0.25	6
	F1HP06	DN100		Ø 64		0...0.25	6
DRM-638 PN16 	F25P16	DN25	flange to EN1092-1, capillary	Ø 24	+250 °C	0...1.6	16
	F32P16	DN32		Ø 30		0...1.6	16
	F40P16	DN40		Ø 38		0...1	16
	F50P16	DN50		Ø 48		0...0.6	16
	F65P16	DN65		Ø 64		0...0.25	16
	F80P16	DN80		Ø 64		0...0.25	16
	F1HP16	DN100		Ø 64		0...0.25	16
DRM-638 PN40 	F25P40	DN25	flange to EN1092-1, capillary	Ø 24	+250 °C	0...1.6	40
	F32P40	DN32		Ø 30		0...1.6	40
	F40P40	DN40		Ø 38		0...1	40
	F50P40	DN50		Ø 48		0...0.6	40
	F65P40	DN65		Ø 64		0...0.25	40
	F80P40	DN80		Ø 64		0...0.25	40
	F1HP40	DN100		Ø 64		0...0.25	40
DRM-639 150 lbs 	A25P150	1"	flange to ASME B16.5, direct	Ø 30	+80 °C	0... 15 psi	145 psi
	A32P150	1¼"		Ø 38		0... 15 psi	145 psi
	A40P150	1½"		Ø 38		0... 15 psi	145 psi
	A50P150	2"		Ø 48		0... 10 psi	145 psi
	A63P150	2½"		Ø 48		0... 10 psi	145 psi
	A75P150	3"		Ø 64		0... 4 psi	145 psi
	A85P150	3½"		Ø 64		0... 4 psi	145 psi
A1HP150	4"	Ø 64	0... 4 psi	145 psi			
DRM-639 300 lbs 	A25P300	1"	flange to ASME B16.5, direct	Ø 30	+80 °C	0... 15 psi	290 psi
	A32P300	1¼"		Ø 38		0... 15 psi	290 psi
	A40P300	1½"		Ø 38		0... 15 psi	290 psi
	A50P300	2"		Ø 48		0... 10 psi	290 psi
	A63P300	2½"		Ø 48		0... 10 psi	290 psi
	A75P300	3"		Ø 64		0... 4 psi	290 psi
	A85P300	3½"		Ø 64		0... 4 psi	290 psi
A1HP300	4"	Ø 64	0... 4 psi	290 psi			
DRM-639 600 lbs 	A25P600	1"	flange to ASME B16.5, direct	Ø 30	+80 °C	0... 15 psi	580 psi
	A32P600	1¼"		Ø 38		0... 15 psi	580 psi
	A40P600	1½"		Ø 38		0... 15 psi	580 psi
	A50P600	2"		Ø 48		0... 10 psi	580 psi
	A63P600	2½"		Ø 48		0... 10 psi	580 psi
	A75P600	3"		Ø 64		0... 4 psi	580 psi
	A85P600	3½"		Ø 64		0... 4 psi	580 psi
A1HP600	4"	Ø 64	0... 4 psi	580 psi			

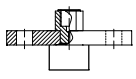
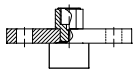
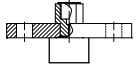
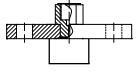
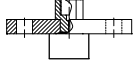

Diaphragm seal models (direct or remote assembly) (continued)

Model DRM	Size code	Size	Note	Ø Diaphragm	Max. medium temperature	Min. span [bar]	Max. span [bar]
DRM-639 1500 lbs 	A25P1K5	1"	flange to ASME B16.5, direct	Ø 30	+80 °C	0... 15 psi	1450 psi
	A32P1K5	1 ¼"		Ø 38		0... 15 psi	1450 psi
	A40P1K5	1 ½"		Ø 38		0... 15 psi	1450 psi
	A50P1K5	2"		Ø 48		0... 10 psi	1450 psi
	A63P1K5	2 ½"		Ø 48		0... 10 psi	1450 psi
	A75P1K5	3"		Ø 64		0... 4 psi	1450 psi
	A1HP1K5	4"		Ø 64		0... 4 psi	1450 psi
DRM-640 150 lbs 	A25P150	1"	flange to ASME B16.5, capillary	Ø 30	+250 °C	0... 15 psi	145 psi
	A32P150	1 ¼"		Ø 38		0... 15 psi	145 psi
	A40P150	1 ½"		Ø 38		0... 15 psi	145 psi
	A50P150	2"		Ø 48		0... 10 psi	145 psi
	A63P150	2 ½"		Ø 48		0... 10 psi	145 psi
	A75P150	3"		Ø 64		0... 4 psi	145 psi
	A85P150	3 ½"		Ø 64		0... 4 psi	145 psi
A1HP150	4"	Ø 64	0... 4 psi	145 psi			
DRM-640 300 lbs 	A25P300	1"	flange to ASME B16.5, capillary	Ø 30	+250 °C	0... 15 psi	290 psi
	A32P300	1 ¼"		Ø 38		0... 15 psi	290 psi
	A40P300	1 ½"		Ø 38		0... 15 psi	290 psi
	A50P300	2"		Ø 48		0... 10 psi	290 psi
	A63P300	2 ½"		Ø 48		0... 10 psi	290 psi
	A75P300	3"		Ø 64		0... 4 psi	290 psi
	A85P300	3 ½"		Ø 64		0... 4 psi	290 psi
A1HP300	4"	Ø 64	0... 4 psi	290 psi			
DRM-640 600 lbs 	A25P600	1"	flange to ASME B16.5, capillary	Ø 30	+250 °C	0... 15 psi	580 psi
	A32P600	1 ¼"		Ø 38		0... 15 psi	580 psi
	A40P600	1 ½"		Ø 38		0... 15 psi	580 psi
	A50P600	2"		Ø 48		0... 10 psi	580 psi
	A63P600	2 ½"		Ø 48		0... 10 psi	580 psi
	A75P600	3"		Ø 64		0... 4 psi	580 psi
	A85P600	3 ½"		Ø 64		0... 4 psi	580 psi
A1HP600	4"	Ø 64	0... 4 psi	580 psi			
DRM-640 1500 lbs 	A25P1K5	1"	flange to ASME B16.5, capillary	Ø 30	+250 °C	0... 15 psi	1450 psi
	A32P1K5	1 ¼"		Ø 38		0... 15 psi	1450 psi
	A40P1K5	1 ½"		Ø 38		0... 15 psi	1450 psi
	A50P1K5	2"		Ø 48		0... 10 psi	1450 psi
	A63P1K5	2 ½"		Ø 48		0... 10 psi	1450 psi
	A75P1K5	3"		Ø 64		0... 4 psi	1450 psi
	A1HP1K5	4"		Ø 64		0... 4 psi	1450 psi

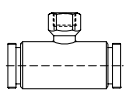
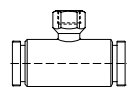
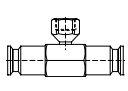
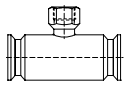

Diaphragm seal models (direct or remote assembly) (continued)

Model DRM	Size code	Size	Note	Ø Diaphragm	Max. medium temperature	Min. span [bar]	Max. span [bar]
DRM 500 ISO Sterile 	D15	DN15	inline, direct	inline	+80 °C	0...1.6	40
	D20	DN20		inline		0...1.6	40
	D25	DN25		inline		0...0.6	40
	D32	DN32		inline		0...0.6	40
	D40	DN40		inline		0...0.4	40
	D50	DN50		inline		0...0.4	40
DRM 501 ISO Sterile 	D15	DN15	inline, capillary	inline	+80 °C	0...1.6	40
	D20	DN20		inline		0...1.6	40
	D25	DN25		inline		0...0.6	40
	D32	DN32		inline		0...0.6	40
	D40	DN40		inline		0...0.4	40
	D50	DN50		inline		0...0.4	40
DRM 502 Clamp ISO 2852 	D15	DN15	inline, direct	inline	+80 °C	0...1.6	40
	D20	DN20		inline		0...1.6	40
	D25	DN25		inline		0...0.6	40
	D32	DN32		inline		0...0.6	40
	D40	DN40		inline		0...0.4	40
	D50	DN50		inline		0...0.4	40
DRM 503 Clamp ISO 2852 	D15	DN15	inline, capillary	inline	+80 °C	0...1.6	40
	D20	DN20		inline		0...1.6	40
	D25	DN25		inline		0...0.6	40
	D32	DN32		inline		0...0.6	40
	D40	DN40		inline		0...0.4	40
	D50	DN50		inline		0...0.4	40

Application Index

Please fill out the following Application Data Sheet while inquiring/ordering model MAN-SC/-LC assembly with diaphragm seal model DRM

Order/ Inquiry Ref./ Item No.

Pressure Transmitter (Model, calibration range)	
Diaphragm seal (Model, size code)	
Diaphragm material of DRM (wetted part)	

Medium:	
Operating density	g/cm ²
Operating viscosity	cSt

Temperature:	nominal	minimal	maximal	
Medium temperature				°C/°F
Ambient temperature				°C/°F
Rinsing temperature diaphragm seal				°C/°F
Rinsing temperature capillary				°C/°F



Application Index (continued)

Please fill out the following Application Data Sheet while inquiring/ordering model MAN-SC/-LC assembly with diaphragm seal model DRM

Order/ Inquiry Ref./ Item No.

Pressure specification:	Value	
1.1) Operating pressure static	or 1.2	bar/psi
1.2) Operating pressure dynamic min + max	or 1.3	bar/psi
1.3) Operating pressure as frequency in Hz		Hz
2.) Max. negative pressure		
3.) Max. over pressure		
4.1) Display damping: without / light / middle / strong	or 4.2	
4.2) Pressure decrease with time + range		

Arrangement with direct mounting:	
1.) Standard (DRM six o'clock position)	or 2.0
2.) Left (DRM nine o'clock position)	or 3.0
3.) Right (DRM three o'clock position, see Fig. 1)	or 4.0
4.) Special, with description	or 5.0
5.) Position (vertically/horizontally) with pipe diaphragm seal	

Arrangement with capillary:	
1.) Standard (DRM six o'clock position)	or 2.0
2.) on the side (DRM three or 9 o'clock position)	or 3.0
3.) Top (DRM twelve o'clock position)	or 4.0
4.) Special, with description	or 5.0
5.) Position (vertically/horizontally) with pipe diaphragm seal	

Capillary (stainless steel 1.4571/316Ti):	
Length in 'mm'	mm
Protection hose required (Yes/No)	

Height adjustment:	
No	
1.) MAN-SC/-LC same level as DRM (diaphragm - pressure transmitter)	or 2.)
Yes	
2.) MAN-SC/-LC higher than DRM (specify Δh as in Fig. 2 or Fig. 3)	or 3.) m
3.) MAN-SC/-LC lower than DRM (specify Δh as in Fig. 2 or Fig. 3)	m

Options:	
Extended diaphragm seal (Tick mark the desired box)	
No	
Yes	
If Yes, length 'R _L ' of extended diaphragm seal (in mm)	
If Yes, length 'R _L ' of extended diaphragm seal (in inches)	
Filling liquid (Tick mark the desired box)	
Glycerine oil (silicone free, food grade) for operation temp. (-10 ... +80 °C)	
Paraffine oil (silicone free, food grade) for operation temp. (-10 ... +120 °C)	
Silicone oil for operation temp. (-40 ... +200 °C)	
Silicone oil for operation temp. (-20 ... +350 °C)	
Silicone oil for operation temp. (-20 ... +400 °C)	